

Contestant Number _____

Contestant Name _____
(to be filled in after judging)

UIL A+ Creative Writing Evaluation Sheet

Elementary

Evaluation criteria are listed in the order of importance. Circle score rating in each of the three major areas of *creativity & interest*, *organization*, and *correctness of style* and tally the points.

(60%) 1 2 3 4 5 6 7 8 9 10 11 12

CREATIVITY & INTEREST Interest depends primarily upon substance. It depends next upon clarity and upon including specific details and examples, which individualize the story as an outgrowth of the writer's character and experience.

(30%) 1 2 3 4 5 6

Organization A well-organized story will present ideas in a logical and coherent manner.

(10%) 1 2

Correctness of Style Grammatical correctness of style includes avoiding errors in sentence structure, punctuation, grammar, spelling and word usage.

TOTAL SCORE: _____/20

CONSTRUCTIVE COMMENTS FOR THE CONTESTANT

Please read "Instructions for the Judges" before evaluating second grade Creative Writing contestants' papers. Please make your comments using language understandable to the contestant and make all comments constructive and supportive. While judges are to consider all three elements in selecting the most effective compositions, they should weigh creativity and interest more than organization, and organization more than correctness of style.

Judge's signature _____



A+ Creative Writing Contest

INVITATIONAL

GRADE 2

2020-2021

Write a story on your own paper. You must write about at least one of the things shown on this page. You may use as many of the pictures as you want.



piano

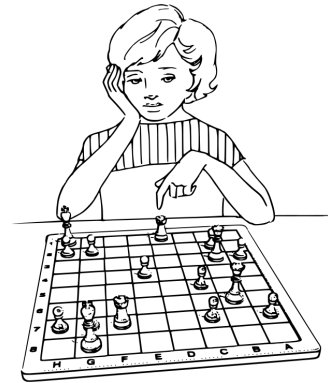

board game



backpack

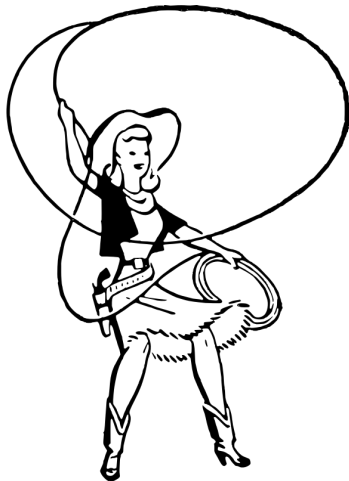

cowgirl

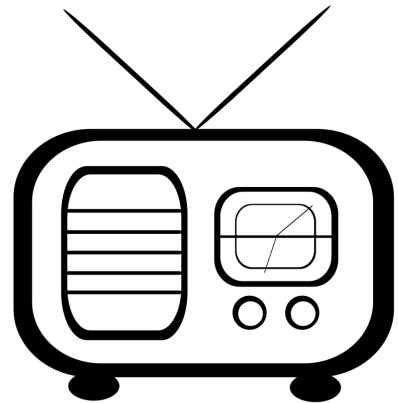

radio



A+ Creative Writing Contest

FALL/WINTER DISTRICT

GRADE 2

2020-2021

Write a story on your own paper. You must write about at least one of the things shown on this page. You may use as many of the pictures as you want.

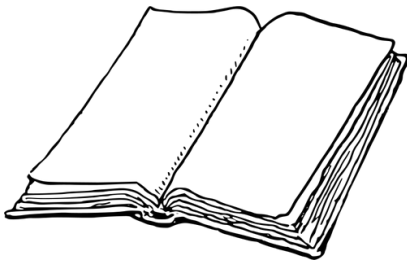

book



ship

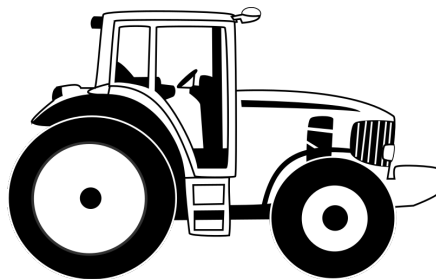

tractor



chef

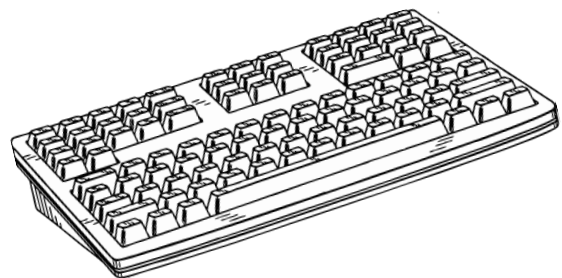

keyboard



A+ Creative Writing Contest

SPRING DISTRICT

GRADE 2

2020-2021

Write a story on your own paper. You must write about at least one of the things shown on this page. You may use as many of the pictures as you want.



garden

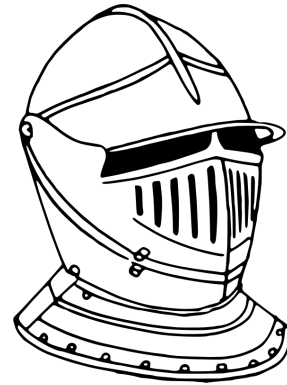

helmet

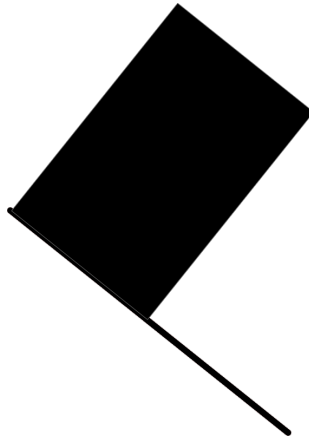

flag

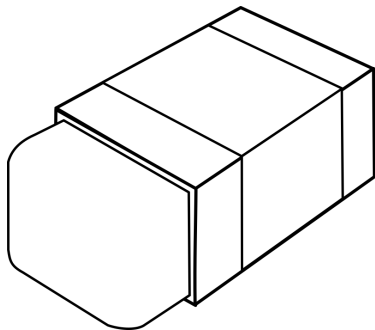

eraser

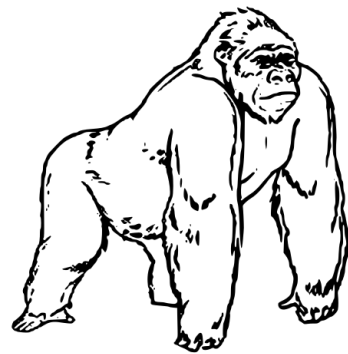

gorilla